

RF Power Field Effect Transistor

N-Channel Enhancement-Mode Lateral MOSFET

Designed for broadband commercial and industrial applications with frequencies from 865 to 895 MHz. The high gain and broadband performance of this device make it ideal for large-signal, common source amplifier applications in 26 volt base station equipment.

- Typical CDMA Performance @ 880 MHz, 26 Volts, $I_{DQ} = 1900$ mA
 IS-95 CDMA Pilot, Sync, Paging, Traffic Codes 8 Through 13
 Output Power — 40 Watts
 Power Gain — 16.5 dB
 Efficiency — 25.5%
 Adjacent Channel Power —
 750 kHz: -46.2 dBc in 30 kHz BW
 1.98 MHz: -60 dBc in 30 kHz BW
- Capable of Handling 10:1 VSWR, @ 26 Vdc, 880 MHz, 40 Watts CW Output Power

Features

- Internally Matched for Ease of Use
- Device Designed for Push-Pull Operation Only
- Integrated ESD Protection
- Designed for Maximum Gain and Insertion Phase Flatness
- Excellent Thermal Stability
- Characterized with Series Equivalent Large-Signal Impedance Parameters
- RoHS Compliant
- In Tape and Reel. R3 Suffix = 250 Units per 56 mm, 13 inch Reel.



**880 MHz, 200 W, 26 V
 LATERAL N-CHANNEL
 RF POWER MOSFET**

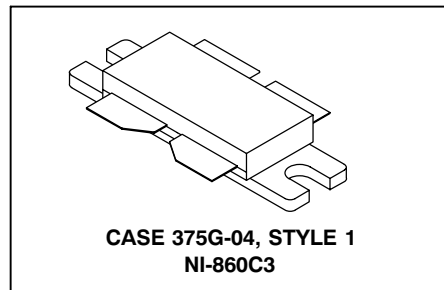

ARCHIVE INFORMATION

ARCHIVE INFORMATION

Table 1. Maximum Ratings

Rating	Symbol	Value	Unit
Drain-Source Voltage	V_{DSS}	- 0.5, +65	Vdc
Gate-Source Voltage	V_{GS}	- 0.5, +15	Vdc
Total Device Dissipation @ $T_C = 25^\circ\text{C}$ Derate above 25°C	P_D	565 3.2	W W/ $^\circ\text{C}$
Storage Temperature Range	T_{stg}	- 65 to +150	$^\circ\text{C}$
Case Operating Temperature	T_C	150	$^\circ\text{C}$
Operating Junction Temperature	T_J	200	$^\circ\text{C}$

Table 2. Thermal Characteristics

Characteristic	Symbol	Value (1)	Unit
Thermal Resistance, Junction to Case	$R_{\theta JC}$	0.31	$^\circ\text{C}/\text{W}$

Table 3. ESD Protection Characteristics

Test Conditions	Class
Human Body Model	1 (Minimum)
Machine Model	M3 (Minimum)
Charge Device Model	C5 (Minimum)

1. MTTF calculator available at <http://www.freescale.com/rf>. Select Software & Tools/Development Tools/Calculators to access MTTF calculators by product.

Table 4. Electrical Characteristics ($T_C = 25^\circ\text{C}$ unless otherwise noted)

Characteristic	Symbol	Min	Typ	Max	Unit
Off Characteristics ⁽¹⁾					
Zero Gate Voltage Drain Leakage Current ⁽⁴⁾ ($V_{DS} = 65\text{ Vdc}$, $V_{GS} = 0$)	I_{DSS}	—	—	10	μA
Zero Gate Voltage Drain Leakage Current ⁽⁴⁾ ($V_{DS} = 26\text{ Vdc}$, $V_{GS} = 0$)	I_{DSS}	—	—	1	μA
Gate-Source Leakage Current ($V_{GS} = 5\text{ Vdc}$, $V_{DS} = 0$)	I_{GSS}	—	—	1	μA
On Characteristics					
Gate Threshold Voltage ⁽¹⁾ ($V_{DS} = 10\text{ Vdc}$, $I_D = 330\ \mu\text{A}$)	$V_{GS(th)}$	1.5	2.8	4	Vdc
Gate Quiescent Voltage ⁽³⁾ ($V_{DS} = 26\text{ Vdc}$, $I_D = 1900\text{ mA}$)	$V_{GS(Q)}$	2.5	3.3	4.5	Vdc
Drain-Source On-Voltage ⁽¹⁾ ($V_{GS} = 10\text{ Vdc}$, $I_D = 2.2\text{ A}$)	$V_{DS(on)}$	—	0.2	0.4	Vdc
Forward Transconductance ⁽¹⁾ ($V_{DS} = 10\text{ Vdc}$, $I_D = 6.7\text{ A}$)	g_{fs}	—	8.8	—	S
Dynamic Characteristics ^(1,2)					
Reverse Transfer Capacitance ($V_{DS} = 26\text{ Vdc} \pm 30\text{ mV(rms)}$ ac @ 1 MHz, $V_{GS} = 0\text{ Vdc}$)	C_{rss}	—	3.6	—	pF
Functional Tests ⁽³⁾ (In Freescale Test Fixture, 50 ohm system) Single-Carrier N-CDMA, 1.2288 MHz Channel Bandwidth Carrier, PAR = 9.8 dB @ 0.01% Probability on CCDF					
N-CDMA Common-Source Amplifier Power Gain ($V_{DD} = 26\text{ Vdc}$, $P_{out} = 40\text{ W Avg.}$ N-CDMA, $I_{DQ} = 1900\text{ mA}$, $f = 880\text{ MHz}$)	G_{ps}	15.8	16.5	—	dB
N-CDMA Drain Efficiency ($V_{DD} = 26\text{ Vdc}$, $P_{out} = 40\text{ W Avg.}$ N-CDMA, $I_{DQ} = 1900\text{ mA}$, $f = 880\text{ MHz}$)	η	23	25.5	—	%
Adjacent Channel Power Ratio ($V_{DD} = 26\text{ Vdc}$, $P_{out} = 40\text{ W Avg.}$ N-CDMA, $I_{DQ} = 1900\text{ mA}$, $f = 880\text{ MHz}$; ACPR @ 40 W, 1.23 MHz Bandwidth, 750 kHz Channel Spacing)	ACPR	—	-46.2	-45	dBc
Input Return Loss ($V_{DD} = 26\text{ Vdc}$, $P_{out} = 40\text{ W Avg.}$ N-CDMA, $I_{DQ} = 1900\text{ mA}$, $f = 880\text{ MHz}$)	IRL	9	17.5	—	dB
N-CDMA Common-Source Amplifier Power Gain ($V_{DD} = 26\text{ Vdc}$, $P_{out} = 40\text{ W Avg.}$ N-CDMA, $I_{DQ} = 1900\text{ mA}$, $f = 865\text{ MHz}$ and 895 MHz)	G_{ps}	—	16.5	—	dB
N-CDMA Drain Efficiency ($V_{DD} = 26\text{ Vdc}$, $P_{out} = 40\text{ W Avg.}$ N-CDMA, $I_{DQ} = 1900\text{ mA}$, $f = 865\text{ MHz}$ and 895 MHz)	η	—	25.5	—	%
Adjacent Channel Power Ratio ($V_{DD} = 26\text{ Vdc}$, $P_{out} = 40\text{ W Avg.}$ N-CDMA, $I_{DQ} = 1900\text{ mA}$, $f = 865\text{ MHz}$ and 895 MHz ; ACPR @ 40 W, 1.23 MHz Bandwidth, 750 kHz Channel Spacing)	ACPR	—	-47.5	—	dBc
Input Return Loss ($V_{DD} = 26\text{ Vdc}$, $P_{out} = 40\text{ W Avg.}$ N-CDMA, $I_{DQ} = 1900\text{ mA}$, $f = 865\text{ MHz}$ and 895 MHz)	IRL	—	15	—	dB

- Each side of device measured separately.
- Part internally matched both on input and output.
- Measurement made with device in push-pull configuration.
- Drains are tied together internally as this is a total device value.

Table 5. 880 MHz Test Circuit Component Designations and Values

Part	Description	Part Number	Manufacturer
B1, B2	11 Ω RF Beads, Surface Mount (0805)	2508051107Y0	Fair-Rite
Balun 1, Balun 2	0.8-1 GHz Xinger Balun	3A412	Anaren
C1	27 pF Chip Capacitor	ATC100B270JT500XT	ATC
C2	12 pF Chip Capacitor (0603)	06035J120GBT	AVX / Kyocera
C3, C4	3.3 pF Chip Capacitors (0603)	06035J3R3BBT	AVX / Kyocera
C5	9.1 pF Chip Capacitor	ATC180R9R1JT500XT	ATC
C6	4.3 pF Chip Capacitor	ATC100B4R3CT500XT	ATC
C7	0.4-2.5 pF Variable Capacitor	27283PC	Gigatronics
C8	12 pF Chip Capacitor	ATC100B120JT500XT	ATC
C9, C10	470 μ F, 63 V Electrolytic Capacitors	EMVY630GTR471MMH05	Nippon
C11, C12, C13, C14	22 μ F, 35 V Tantalum Chip Capacitors	T491X226K035AT	Kemet
C15, C17, C19, C21	0.01 μ F, 100 V Chip Capacitors	C1825C103J1GAC	Kemet
C16, C18	0.56 μ F, 50 V Chip Capacitors	C1825C564J5GAC	Kemet
C20, C22	2.2 μ F, 50 V Chip Capacitors	C1825C225J5RAC3810	Kemet
C23, C24	47 μ F, 16 V Tantalum Chip Capacitors	T491D476K016AT	Kemet
L1	12 nH Inductor (0603)	0603HC-12NHJBU	Coilcraft
L2	22 nH Inductor	B07T-5	Coilcraft
L3, L4	12.5 nH Inductors	A04T-5	Coilcraft
L5, L6	10 nH Inductors (0603)	0603HC-10NHJBU	Coilcraft
R1, R2	24 Ω , 1/4 W Chip Resistors	CRCW120624R0FKEA	Vishay

ARCHIVE INFORMATION

ARCHIVE INFORMATION

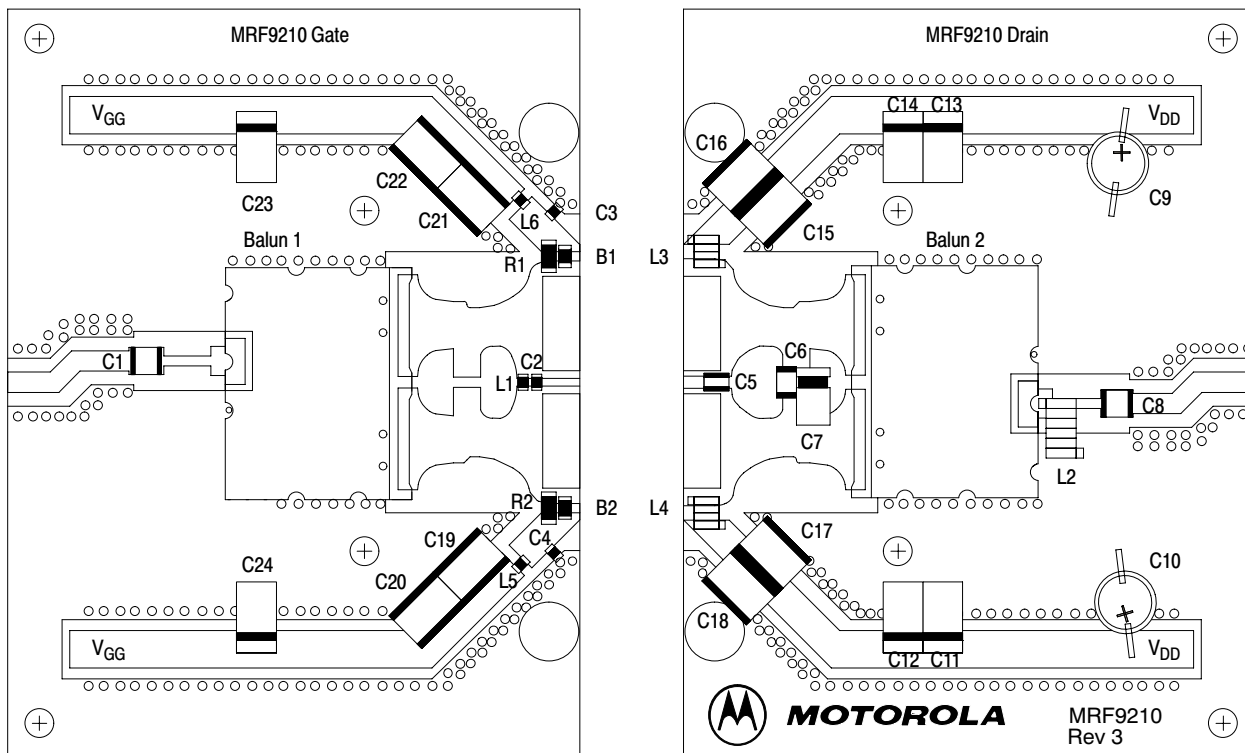

Freescale has begun the transition of marking Printed Circuit Boards (PCBs) with the Freescale Semiconductor signature/logo. PCBs may have either Motorola or Freescale markings during the transition period. These changes will have no impact on form, fit or function of the current product.

Figure 1. 880 MHz Test Circuit Component Layout

TYPICAL CHARACTERISTICS

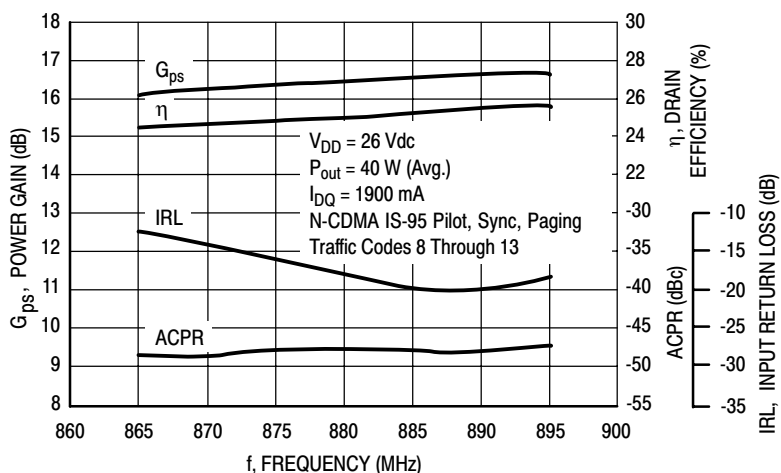

Figure 2. Class AB Broadband Circuit Performance

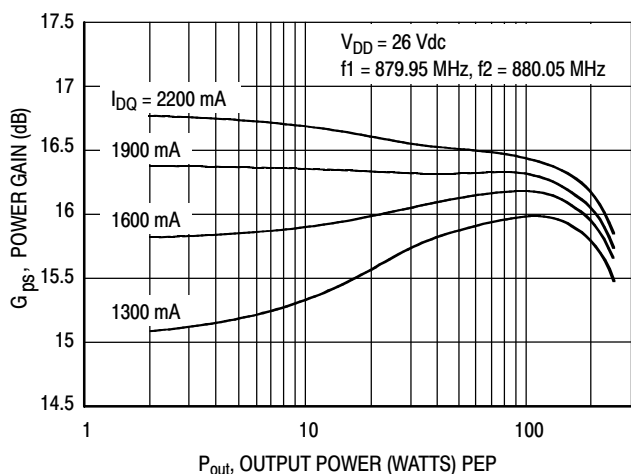

Figure 3. Power Gain versus Output Power

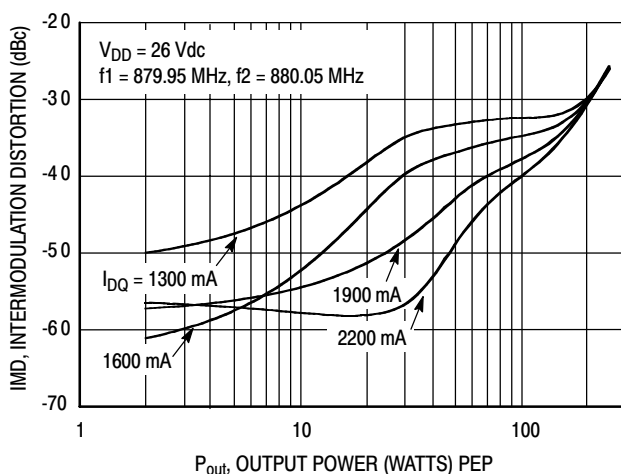

Figure 4. Intermodulation Distortion versus Output Power

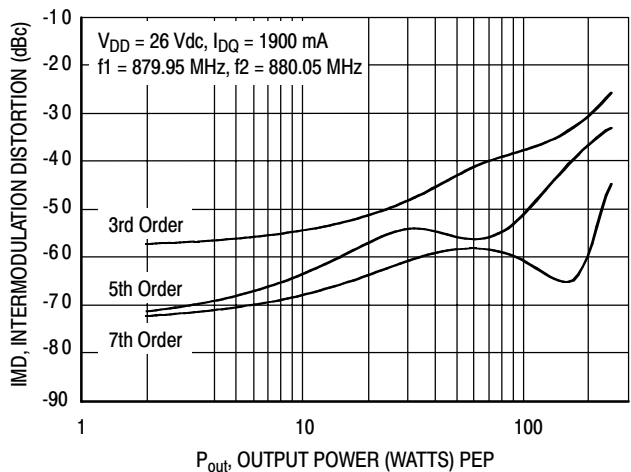

Figure 5. Intermodulation Distortion Products versus Output Power

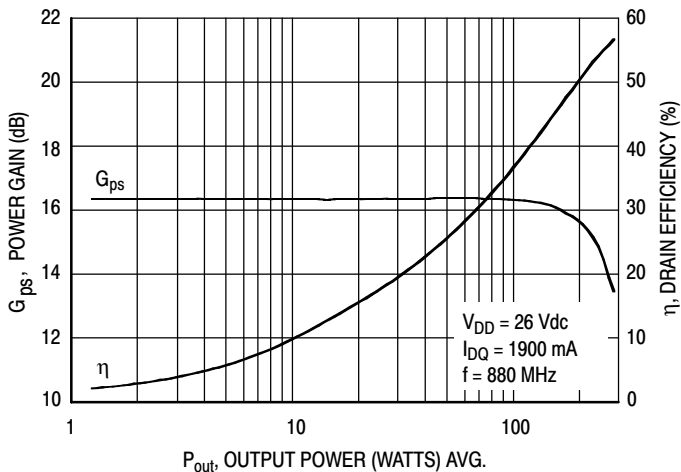

Figure 6. Power Gain and Efficiency versus Output Power

ARCHIVE INFORMATION

ARCHIVE INFORMATION

TYPICAL CHARACTERISTICS

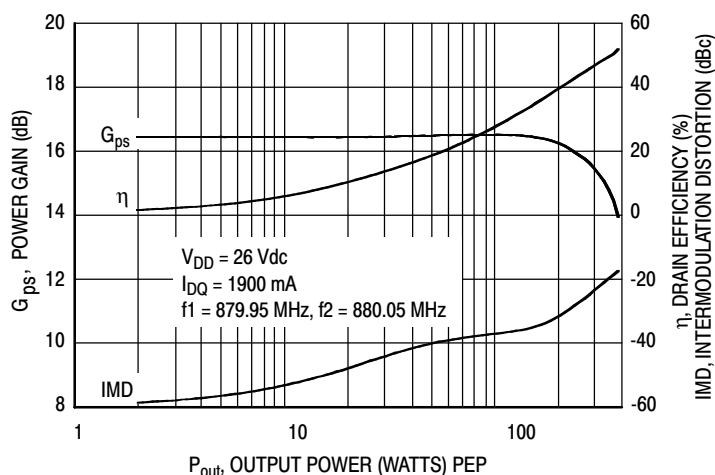

Figure 7. Power Gain, Efficiency and IMD versus Output Power

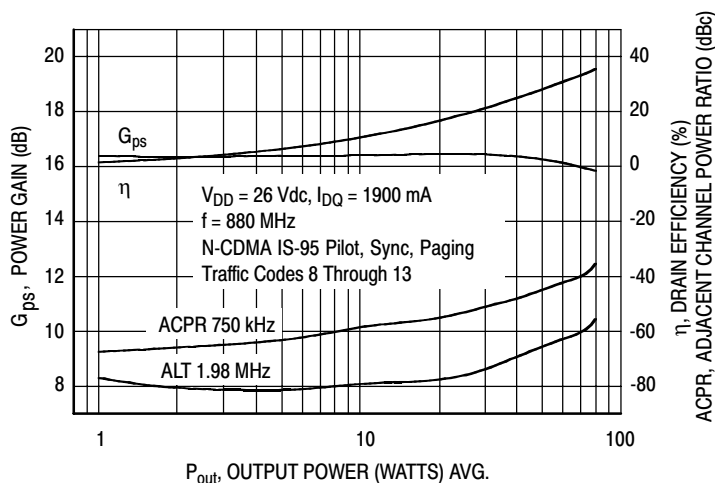

Figure 8. N-CDMA Performance Output Power versus Gain, ACPR, Efficiency

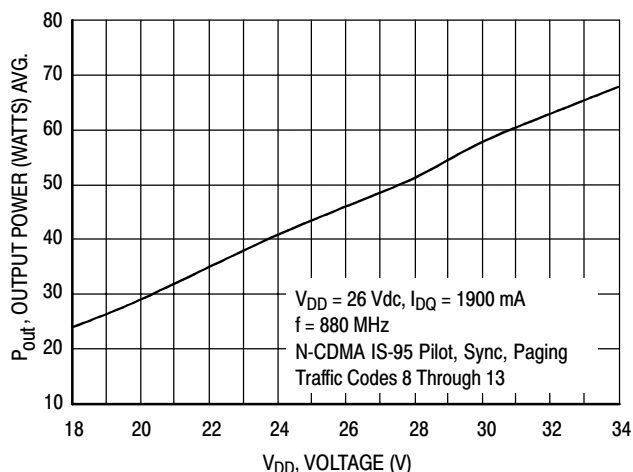

Figure 9. Single-Carrier Maximum N-CDMA Linear Output Power versus Drain Voltage

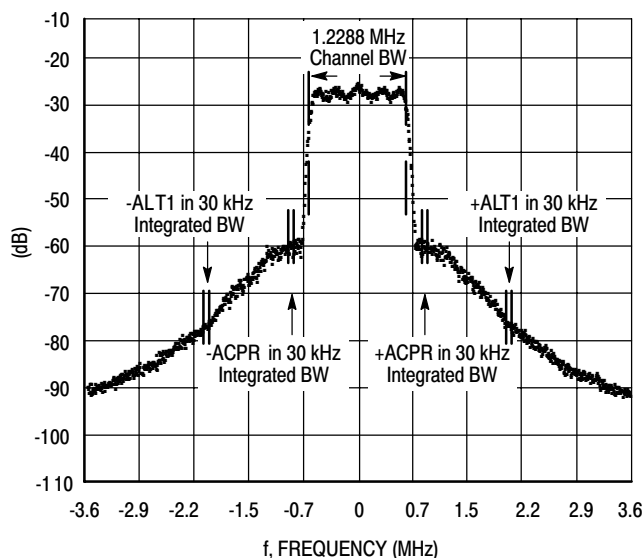
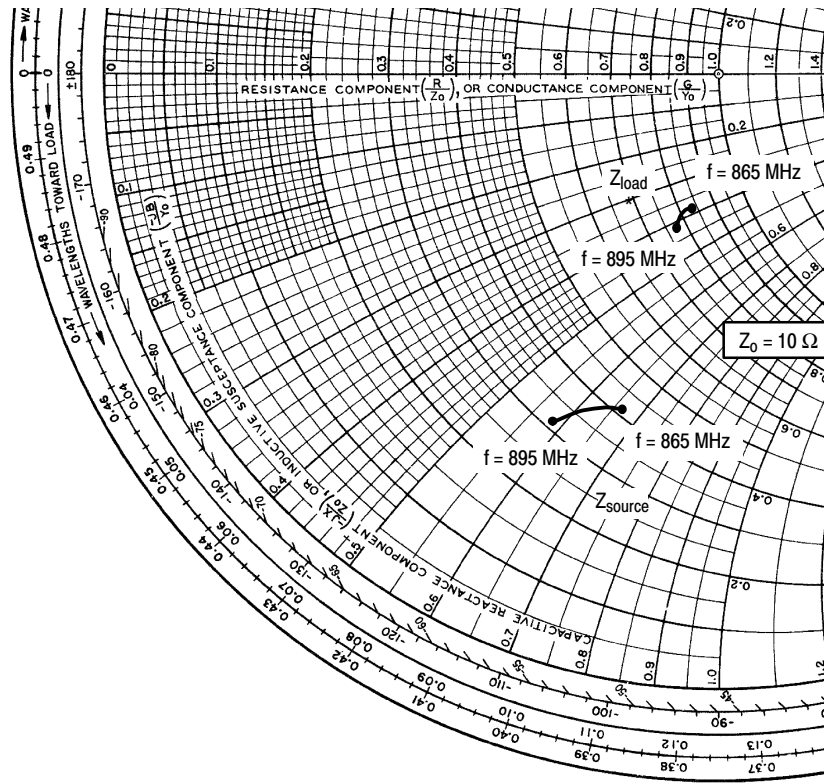

Figure 10. Single-Carrier N-CDMA Spectrum

MRF9210R3

ARCHIVE INFORMATION

ARCHIVE INFORMATION



$V_{DD} = 26\text{ V}$, $I_{DQ} = 1900\text{ mA}$, $P_{out} = 40\text{ W Avg.}$

f MHz	Z_{source} Ω	Z_{load} Ω
865	$4.19 - j6.71$	$8.43 - j3.83$
880	$3.69 - j6.18$	$8.12 - j3.85$
895	$3.17 - j5.85$	$7.84 - j4.08$

Z_{source} = Test circuit impedance as measured from gate to gate, balanced configuration.

Z_{load} = Test circuit impedance as measured from drain to drain, balanced configuration.

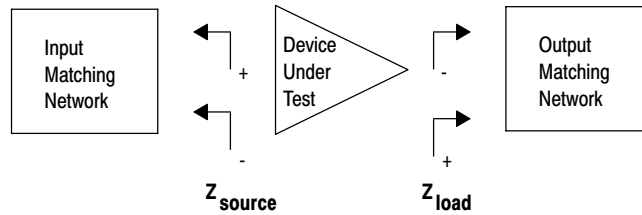
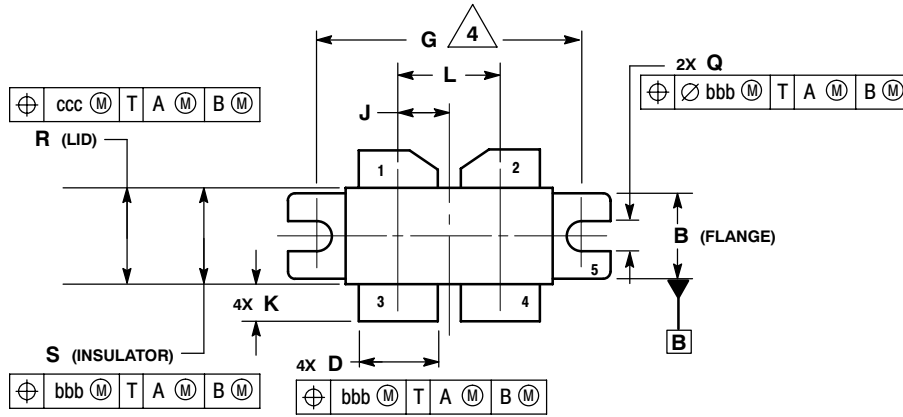

Figure 11. Series Equivalent Source and Load Impedance

PACKAGE DIMENSIONS



- NOTES:
1. CONTROLLING DIMENSION: INCH.
 2. INTERPRET DIMENSIONS AND TOLERANCES PER ASME Y14.5M-1994.
 3. DIMENSION H TO BE MEASURED 0.030 (0.762) AWAY FROM PACKAGE BODY.
 4. RECOMMENDED BOLT CENTER DIMENSION OF 1.140 (28.96) BASED ON 3M SCREW.

DIM	INCHES		MILLIMETERS	
	MIN	MAX	MIN	MAX
A	1.335	1.345	33.91	34.16
B	0.380	0.390	9.65	9.91
C	0.180	0.224	4.57	5.69
D	0.325	0.335	8.26	8.51
E	0.060	0.070	1.52	1.78
F	0.004	0.006	0.10	0.15
G	1.100 BSC		27.94 BSC	
H	0.097	0.107	2.46	2.72
J	0.2125 BSC		5.397 BSC	
K	0.135	0.165	3.43	4.19
L	0.425 BSC		10.8 BSC	
M	0.852	0.868	21.64	22.05
N	0.851	0.869	21.62	22.07
Q	0.118	0.138	3.00	3.30
R	0.395	0.405	10.03	10.29
S	0.394	0.406	10.01	10.31
bbb	0.010 REF		0.25 REF	
ccc	0.015 REF		0.38 REF	

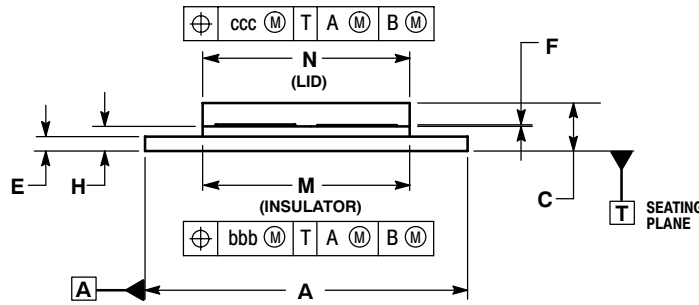

- STYLE 1:
 PIN 1. DRAIN
 2. DRAIN
 3. GATE
 4. GATE
 5. SOURCE

**CASE 375G-04
 ISSUE G
 NI-860C3**

PRODUCT DOCUMENTATION

Refer to the following documents to aid your design process.

Engineering Bulletins

- EB212: Using Data Sheet Impedances for RF LDMOS Devices

REVISION HISTORY

The following table summarizes revisions to this document.

Revision	Date	Description
6	Dec. 2009	<ul style="list-style-type: none"> • Data sheet archived. Part no longer manufactured. • Updated Part Numbers in Table 5, Component Designations and Values, to RoHS compliant part numbers, p. 3 • Added Product Documentation and Revision History, p. 8

ARCHIVE INFORMATION

ARCHIVE INFORMATION

How to Reach Us:

Home Page:
www.freescale.com

Web Support:
<http://www.freescale.com/support>

USA/Europe or Locations Not Listed:
 Freescale Semiconductor, Inc.
 Technical Information Center, EL516
 2100 East Elliot Road
 Tempe, Arizona 85284
 1-800-521-6274 or +1-480-768-2130
www.freescale.com/support

Europe, Middle East, and Africa:
 Freescale Halbleiter Deutschland GmbH
 Technical Information Center
 Schatzbogen 7
 81829 Muenchen, Germany
 +44 1296 380 456 (English)
 +46 8 52200080 (English)
 +49 89 92103 559 (German)
 +33 1 69 35 48 48 (French)
www.freescale.com/support

Japan:
 Freescale Semiconductor Japan Ltd.
 Headquarters
 ARCO Tower 15F
 1-8-1, Shimo-Meguro, Meguro-ku,
 Tokyo 153-0064
 Japan
 0120 191014 or +81 3 5437 9125
support.japan@freescale.com

Asia/Pacific:
 Freescale Semiconductor China Ltd.
 Exchange Building 23F
 No. 118 Jianguo Road
 Chaoyang District
 Beijing 100022
 China
 +86 10 5879 8000
support.asia@freescale.com

For Literature Requests Only:
 Freescale Semiconductor Literature Distribution Center
 P.O. Box 5405
 Denver, Colorado 80217
 1-800-441-2447 or +1-303-675-2140
 Fax: +1-303-675-2150
LDCForFreescaleSemiconductor@hibbertgroup.com

Information in this document is provided solely to enable system and software implementers to use Freescale Semiconductor products. There are no express or implied copyright licenses granted hereunder to design or fabricate any integrated circuits or integrated circuits based on the information in this document.

Freescale Semiconductor reserves the right to make changes without further notice to any products herein. Freescale Semiconductor makes no warranty, representation or guarantee regarding the suitability of its products for any particular purpose, nor does Freescale Semiconductor assume any liability arising out of the application or use of any product or circuit, and specifically disclaims any and all liability, including without limitation consequential or incidental damages. "Typical" parameters that may be provided in Freescale Semiconductor data sheets and/or specifications can and do vary in different applications and actual performance may vary over time. All operating parameters, including "Typicals", must be validated for each customer application by customer's technical experts. Freescale Semiconductor does not convey any license under its patent rights nor the rights of others. Freescale Semiconductor products are not designed, intended, or authorized for use as components in systems intended for surgical implant into the body, or other applications intended to support or sustain life, or for any other application in which the failure of the Freescale Semiconductor product could create a situation where personal injury or death may occur. Should Buyer purchase or use Freescale Semiconductor products for any such unintended or unauthorized application, Buyer shall indemnify and hold Freescale Semiconductor and its officers, employees, subsidiaries, affiliates, and distributors harmless against all claims, costs, damages, and expenses, and reasonable attorney fees arising out of, directly or indirectly, any claim of personal injury or death associated with such unintended or unauthorized use, even if such claim alleges that Freescale Semiconductor was negligent regarding the design or manufacture of the part.

Freescale™ and the Freescale logo are trademarks of Freescale Semiconductor, Inc. All other product or service names are the property of their respective owners.
 © Freescale Semiconductor, Inc. 2008-2009. All rights reserved.